

# SHAD

## SOFT BAGS

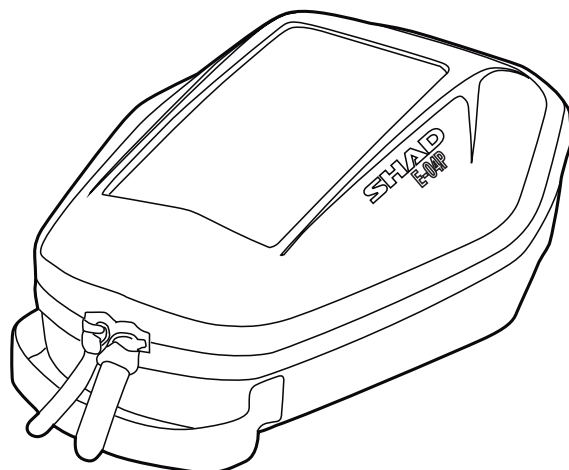

**PATENT**  
PENDING



### X0SE04P Tank Bag E-04P

	Pin System
	Semi rigid
	Capacity 3L
	Water resistant zipper
	Inner pockets
	Reflective
	Outlet for USB charger
	Mobile phone holder
	Touch screen

#### COMPONENTS INCLUDED

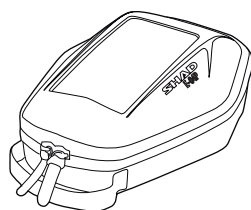

Tank Bag

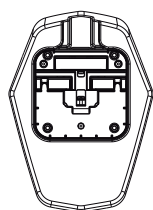

Mechanism

#### COMPONENTS NOT INCLUDED

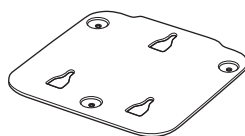

- (GB)** Find the fitting plate for your bike on:
- (E)** Busca la pletina de montaje para tu moto en:
- (F)** Trouvez la platine d'installation pour votre moto sur:



[www.shad.es/en/l22/pin-system](http://www.shad.es/en/l22/pin-system)

### ⚠ WARNING

Make sure the bag and its accessories are properly assembled.

To clean the bag use a damp cloth with neutral soap. Never use solvents or chemical products.

Prolonged exposure to the elements might discolor fabrics and wear away plastic components.

Waterproof zippers and rain covers do not guarantee that the bag is totally waterproof.

Use zippers with care. To open the bags slide zip all the way without forcing.

Maximum load: 1,5 Kg.

Maximum speed: 120 km/h or 74 mph.

SHAD will not hold responsibility for damages caused by an incorrect assembly or use.

### ⚠ PRECAUCIÓN

Asegurarse que la bolsa y todos sus accesorios están correctamente montados.

Si requiere limpiar las bolsas utilice un paño húmedo con jabón neutro, nunca utilice disolventes o productos químicos.

La exposición prolongada a la intemperie puede ocasionar cambios en el color de tejidos y desgaste de componentes plásticos.

Los forros de lluvia no garantizan completa impermeabilidad de la bolsa.

Utilizar las cremalleras con cuidado, para abrir, deslizarlas hasta el final sin forzarlas.

Capacidad de carga: 1,5 Kg. máximo.

La velocidad de la moto con una bolsa tiene que ser de máximo 120 km/h o 74 mph.

SHAD no se hará responsable de los daños causados por un montaje o uso incorrecto.

### ⚠ ATTENTION

Assurez-vous que le sac et tous ses accessoires sont montés correctement.

Si vous avez besoin de nettoyer le sac, passez un drap humide avec un savon neutre. N'utilisez pas de dissolvants ou de produits chimiques.

Une exposition prolongée à l'air libre peut provoquer des changements dans la couleur du tissu et l'usure des composants en plastique.

La housse de pluie n'assure pas l'imperméabilité complète du sac.

Utilisez les fermetures doucement pour ouvrir, faites-les glisser jusqu'au fin sans forcer.

Capacité: 1,5 kg au maximum.

La vitesse de la moto avec un sac devrait être d'un maximum de 120 km/h ou 74 mph

SHAD ne sera pas responsable des dommages causés par un montage incorrect.

# INSTRUCTIONS

1

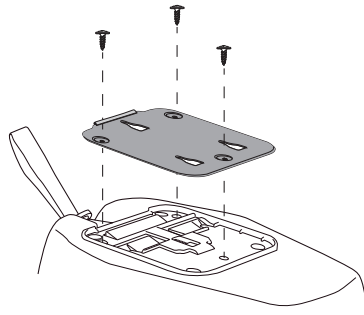

2

**PRESS**

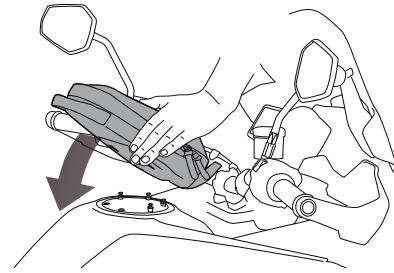

3

**PULL**

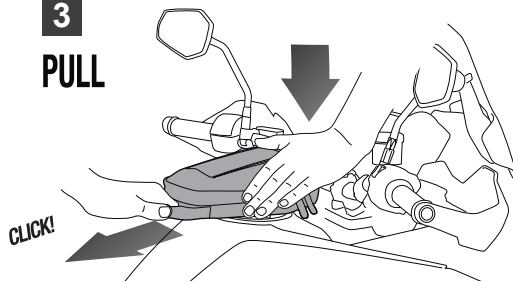

4

**REMOVE**

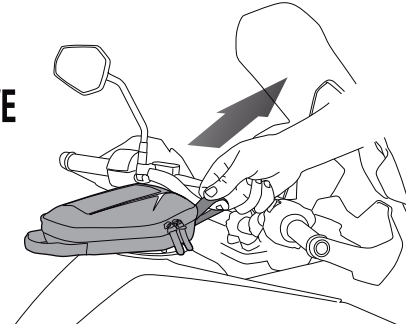

# OTHER FEATURES



Mobile phone holder



Outlet for USB charger

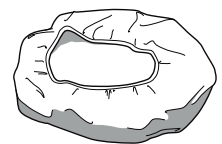
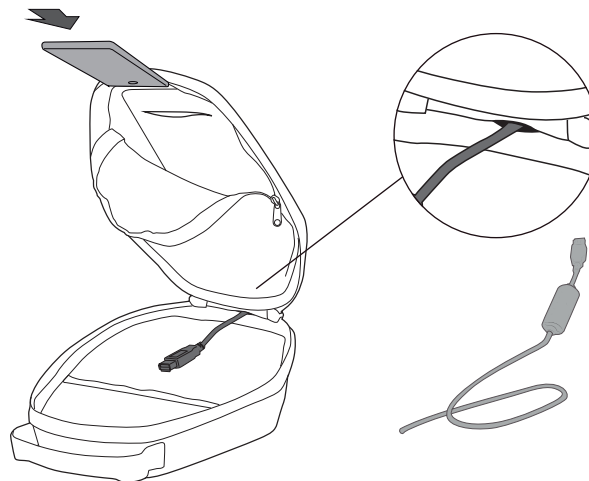

 **Rain Cover**  
Ref: X1SL01

# MORE PRODUCTS FROM SHAD

SH36



reddot award 2015  
winner



MOTOR CASES



SOFT BAGS



COMFORT SEATS



ATV LUGGAGE