





BLACK SPEAR LED REAR SADDLEBAG ACCENTS

6907

THANK YOU FOR CHOOSING KÜRYAKYN!

PROTECT YOURSELF AND OTHERS FROM POSSIBLE INJURY AND PROPERTY DAMAGE OR LOSS. PAY CLOSE ATTENTION TO ALL INSTRUCTIONS, WARNINGS, CAUTIONS, AND NOTICES REGARDING THE INSTALLATION, USE, AND CARE OF THIS PRODUCT.

 WARNING	THIS INDICATION ALERTS YOU TO THE FACT THAT IGNORING THE CONTENTS DESCRIBED HEREIN CAN RESULT IN POTENTIAL DEATH OR SERIOUS INJURY.
 CAUTION	This indication alerts you to the fact that ignoring the contents described herein can result in minor or moderate potential injury.
 NOTICE	This indication alerts you to the fact that ignoring the contents described herein may negatively affect product performance and functionality or damage the product itself or the product to which it is being attached.

MAKE SURE THE FOLLOWING PARTS HAVE BEEN INCLUDED IN THE KIT:

- 2 Black LED Saddlebag Accents
- 1 Hardware Kit containing:
 - 2 Alcohol Pads
 - 2 Rubber Grommets
 - 4 Cord Keepers
 - 8 Black Tape Strips
 - 1 Dielectric Grease Pack
 - 2 Male 3-Pin Connectors
 - 6 Female T-Tap Connectors — '93-'96 HARDWIRE ONLY
 - 6 Male Insulated Spade Connectors — '93-'96 HARDWIRE ONLY
 - 1 (Large 3-Pin) Y-Adapter — '10-'13 ROAD GLIDE + STREET GLIDE
 - 1 (8-Pin) Wiring Pigtail — '97-'13 TOURING
 - 1 (6-Pin) Run-Turn Wiring Adapter — '14-UP TOURING
 - 4 Cable Ties
 - 2 Warning Labels
- 1 Installation instructions

CHROME OR BLACK, INSTALLATION IS THE SAME.

TOOLS SUGGESTED:

Warm water and a clean rag, masking tape, marker, file, center punch, drill and 5/16" bit, wire crimper/stripper

 NOTICE	These installation instructions contain important information. Ensure that the end user receives this copy and is aware of its importance for future reference.
--	--

- STEP 1** Read and understand all steps in the instructions before starting the installation. Park the motorcycle on a hard, level surface and turn off the ignition. Allow the engine and exhaust system to cool.

 WARNING	ACCIDENTAL VEHICLE START-UP COULD CAUSE DEATH OR SERIOUS INJURY, REMOVE THE MAIN FUSE BEFORE PROCEEDING.
---	---

CUSTOMER SERVICE

877.370.3604 (toll free)

INSTALLATION QUESTIONS

techsupport@kuryakyn.com
or call 715.247.2983

LIMITED WARRANTY

Kuryakyn warrants that any Kuryakyn products sold hereunder, shall be free of defects in materials and workmanship for a period of one (1) year from the date of purchase by the consumer excepting the following provisions:

- Kuryakyn shall have no obligation in the event the customer is unable to provide a receipt showing the date the customer purchased the product(s).
 - The product must be properly installed, maintained and operated under normal conditions.
 - Kuryakyn makes no warranty, expressed or implied, with respect to any gold plated products.
 - Kuryakyn shall not be liable for any consequential and incidental damages, including labor and paint, resulting from failure of a Kuryakyn product, failure to deliver, delay in delivery, delivery in nonconforming condition, or for any breach of contract or duty between Kuryakyn and a customer.
- Kuryakyn products are often intended for use in specific applications. Kuryakyn makes no warranty if a Kuryakyn product is used in applications other than intended.
- Kuryakyn electrical products are warranted for one (1) year from the date of purchase by the consumer. L.E.D.'S contained in components of Kuryakyn products will be warranted for defects in materials and workmanship for 3 years from the date of purchase where as all other components shall be warranted for one(1) year. This includes, but is not limited to; control modules, wiring, chrome & other components.

• Kuryakyn makes no warranty of any kind in regard to other manufacturer's products distributed by Kuryakyn. Kuryakyn will pass on all warranties made by the manufacturer and where possible, will expedite the claim on behalf of the customer, but ultimately, responsibility for disposition of the warranty claim lies with the manufacturer.

ABOUT OUR CATALOG

For purchasing Kuryakyn® products, you can receive a complete catalog free of charge. Send the Proof-of-Purchase below with your address to: Kuryakyn
454 County Road V V
Somerset, WI 54025-9031
Please indicate either Accessories Catalog for Harley-Davidson® or GL & Metric Cruisers.

Be sure to ask your local dealer about other Kuryakyn® products, the motorcycle parts and accessories designed for riders by riders.

©2005 Kuryakyn USA® All Rights reserved.



BIKE PREP:

NOTICE

Prepare a clean work area before beginning this installation; ensure that it is a flat, sturdy surface at a comfortable working height. Cover the surface with a CLEAN, DRY blanket or towel to prevent scratching the paint or chrome. Keep the area clean during the installation; remove all debris after filing and drilling.

STEP 2 Take everything out of the saddlebags.

NOTICE

Ensure proper adhesion of this product. Remove all grease, oil, bugs, dirt and other debris (including wax and polish) from the installation area. Kuryakyn will not provide warranty coverage on products or components lost or damaged due to improper installation.

Do not attempt this installation in temperatures below 50° F (10° C). Proper adhesive bonding ONLY occurs above 50° F (10° C).

STEP 3 Use warm, soapy water and a clean rag to remove all grease, oil, bugs, dirt and other debris (including wax and polish) from the rear and inside of the saddlebags; allow them to dry.

STEP 4 Remove the seat and left side-cover; remove the main fuse.

STEP 5 With the saddlebag lid open, position one of the included Accents as shown in **PIC 1**; use masking tape and a marker to make alignment marks on the saddlebag.

NOTICE

Double check all reference marks made on the saddlebag **BEFORE** removing material. Kuryakyn is not responsible for incidental or consequential damages resulting from this installation.

STEP 6 Make a mark on the saddlebag where the wiring exits the top of the Accent; remove the Accent. Use a file to remove about a 1/4" of material from the flange on the top edge of the saddlebag as shown in **PIC 2**. Ensure there are no sharp edges.

STEP 7 Repeat **STEPS 5 and 6** for the other saddlebag.

STEP 8 Remove both of the saddlebags; set them on a soft sturdy surface.

STEP 9 Use a center punch to make a pilot mark on the saddlebag at the location shown in **PIC 3**; drill a 5/16" hole; install one of the included grommets in the hole. Repeat for the other side.

INSTALL THE ACCENTS:

STEP 10 Clean the installation area shown in **PIC 2** on both saddlebags with one of the included alcohol pads.

STEP 11 Use your fingernail to activate the adhesive on one of the Accents by rubbing the red backing; remove and discard the backing.

STEP 12 Align the Accent with the marks made in **STEP 5**; press into place for at least 60 seconds; full bonding will occur in 24 hours.

Repeat for the other saddlebag.

-cont.-

Kuryakyn®



PAGE
2

STEP 13 Route the wiring through the notch, along the inside of the saddlebag, and through the grommet as shown in **PIC 4**; secure with the included Cord Keepers; you may further secure the wiring to the inside of the saddlebag with the included Black Tape Strips.

STEP 14 Repeat for the other side; reinstall the saddlebags.

CONNECT THE WIRING:

NOTICE

Dielectric grease inhibits moisture and prevents corrosion. Kuryakyn recommends the use of the included dielectric grease on ALL electrical connections. Apply dielectric grease directly to mating surfaces.

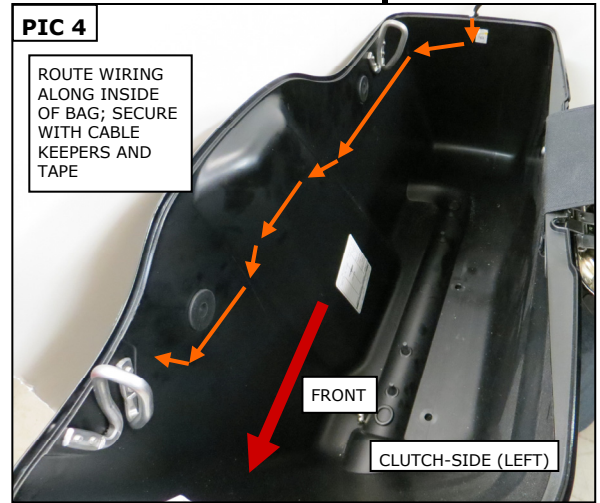

NOTE: The Accents **MUST** be connected (whether using an Adaptor or hardwiring) "upstream" of any existing control module. Example: Main harness, Accent Adapter/Hardwire, Existing Controller, Rear Lighting Harness.

STEP 15 Insert the terminals from the Accents into the included 3-Pin Male Connectors **EXACTLY** as shown in **PIC 5 and 6**. Ensure that the small metal tab on the under side of the terminal "clicks" into place in the connector.

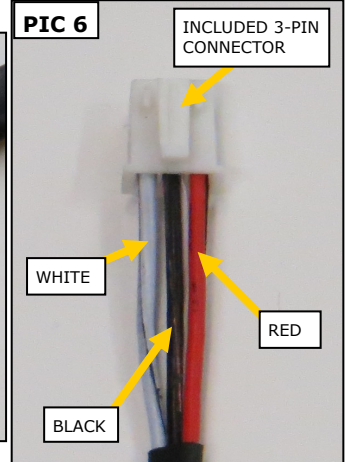
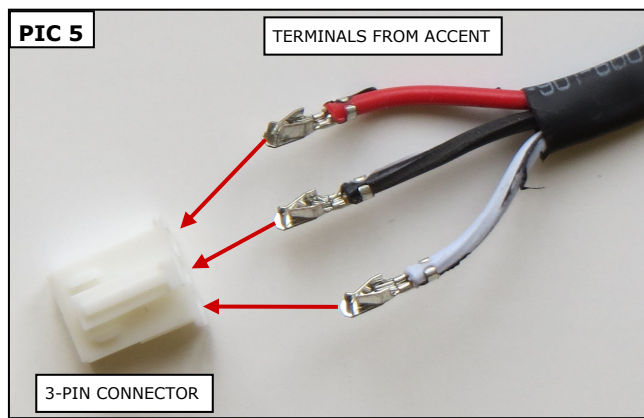

NOTE: Refer to **PIC 7**. Determine which of the included adapters is required for your model bike, ('93-'96 Models skip to **STEP 19**) then move on to **STEP 16**.

STEP 16 Locate and separate the rear lighting harness connectors in the under-seat area OR left side-cover.

Apply some of the included Dielectric Grease to the terminal ends of the included Adapter, then connect it inline.

'14-UP Touring = 6-Pin Adapter, under-seat area

'10-'13 Street + Road Glide = Large 3-Pin Adapter, left side-cover

'97-'13 Touring = 8-Pin Adapter, under-seat area

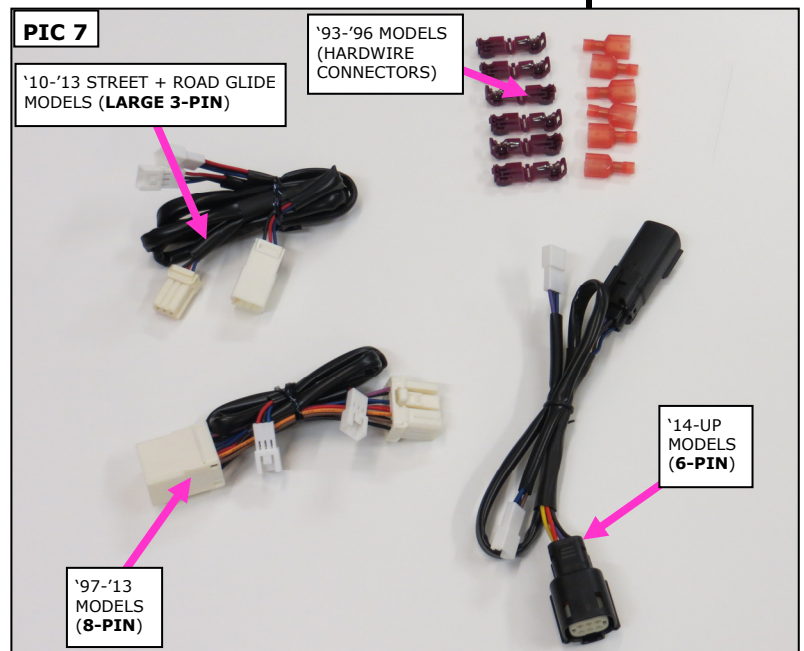

-cont.-

STEP 17

(**'14-Up Models only**) Connect the 3-pin connector from the **Right** Accent to the 3-pin connector with **BROWN** wire on the Adapter.

Connect the 3-pin connector from the **Left** Extension to the 3-pin connector with **VIOLET** wire on the Adapter.

RIGHT = BROWN
LEFT = VIOLET

'14-Up Models ONLY — Accent lights will function as Run-Turn-Brake.

Reinstall the main fuse; **Skip to STEP 21.**

STEP 18

(**'97-'13 ALL Models**) Connect the 3-Pin Connectors from the Accent to the 3-Pin connectors on the Adapter; the connectors are **NOT** side-specific. Accent lights will function as Run-Brake.

Reinstall the main fuse; Skip to **STEP 21.**

STEP 19

(**'93-'96 Models only**) Reinstall the main fuse. Use a test light and a model specific service manual to locate left-and right-turn signal-OR brake-power (HI), run power (LOW), and a ground.

NOTE:

Use the included Female T-Taps and Male Insulated Spade Connectors (PIC 7 on PAGE 3) to hardwire the Accents to the wiring harness. The Accents can be wired as Run-Turn or Run-Brake depending on which wires are selected.

STEP 20

Refer to **PIC 8**. Crimp the included Female T-Taps onto the wires from **STEP 19**.

Cut the terminals off of the wires from the Accents; strip the casing back about a 3/8"; crimp the included Male Insulated Spade Connectors onto the wires as shown in **PIC 9**.

Refer to **FIG 1 and PIC 10**. Connect the Male Spade Connectors to the Female T-Taps.

WHITE = HI (TURN OR BRAKE)
BLACK = GROUND
RED = LOW (RUN)

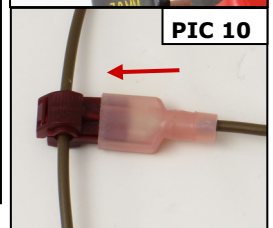
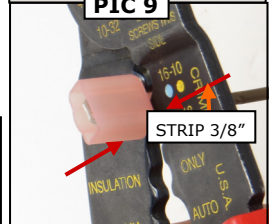
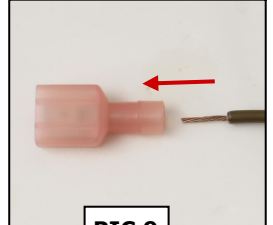
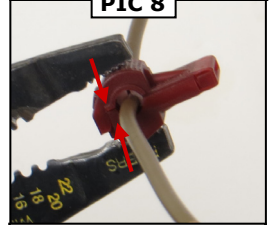
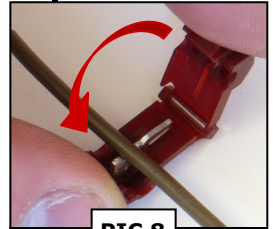
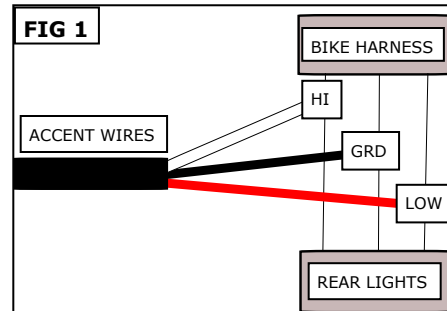

STEP 21

Turn **IGN ON**; ensure proper function of the new and existing lights; turn **IGN OFF**.

STEP 22

Secure all extra wiring out of harms way with the included Cable Ties.

NOTICE

Secure all wiring away from any moving parts, pinch points or extreme heat. Kuryakyn WILL NOT provide warranty coverage on any electrical component that fails due to pinched, crimped, broken, abraded, melted or frayed wires.

STEP 23

Stick the included Warning Labels to the inside to each saddlebag as shown in **PIC 11**.

The small, white, 3-pin connectors **MUST** be separated **BEFORE** removing the saddlebags.

STEP 24

Reinstall the left side cover and seat. Ensure proper operation of **ALL** lighting **BEFORE** operating the motorcycle.



VISIBILITY IS A MAJOR CONCERN FOR MOTORCYCLISTS. A LIGHT MALFUNCTION COULD RESULT IN DEATH OR SERIOUS INJURY. ENSURE PROPER LIGHT OPERATION BEFORE RIDING THE MOTORCYCLE.

NOTICE

It is the end user's responsibility to ensure that all of the fasteners (including pre-assembled) are tightened before operation of the motorcycle. Kuryakyn will not provide warranty coverage on products or components lost or damaged due to improper installation or lack of maintenance. Periodic inspection and maintenance are required on all fasteners.

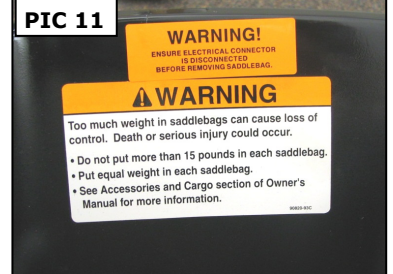

PAGE

4

Ride On!

BLACK SPEAR LED REAR SADDLEBAG ACCENTS

INSTALLATION