



ERGO III ADJUSTABLE CRUISE MOUNTS WITH PREMIUM MINI BOARDS

4082

THANK YOU FOR CHOOSING KÜRYAKYN!

PROTECT YOURSELF AND OTHERS FROM POSSIBLE INJURY AND/OR PROPERTY DAMAGE OR LOSS. PAY CLOSE ATTENTION TO ALL INSTRUCTIONS, WARNINGS, CAUTIONS, AND NOTICES REGARDING THE INSTALLATION, USE, AND CARE OF THIS PRODUCT.

WARNING

THIS INDICATION ALERTS YOU TO THE FACT THAT IGNORING THE CONTENTS DESCRIBED HEREIN CAN RESULT IN POTENTIAL DEATH OR SERIOUS INJURY.

CAUTION

This indication alerts you to the fact that ignoring the contents described herein can result in minor or moderate potential injury.

NOTICE

This indication alerts you to the fact that ignoring the contents described herein may negatively affect product performance and functionality or damage the product itself or the product to which it is being attached.

MAKE SURE THE FOLLOWING PARTS HAVE BEEN INCLUDED IN THE KIT:

- 2 Premium Mini Boards with Adjustable Male Mounts
- 1 Right Side Mount/Arm Assembly
- 1 Left Side Mount/Arm Assembly
- 2 Extension Arms
- 1 Left Side Footpeg Clevis
- 1 Right Side Footpeg Clevis
- 1 Hardware Kit Containing:
 - 4 3/8"-16 X 5/8" Set Screws
 - 2 Adjustable Stops
 - 4 1/4"-20 X 1-1/8" Button Socket Cap Screws
 - 4 1/4"-20 Nylock Nuts
 - 4 1/4"-20 X 5/16" Button Socket Cap Screws
 - 2 3/8"-16 X 1" Socket Head Cap Screws
 - 2 5/16"-18 X 1 Socket Head Cap Screws
 - 2 Thick Wave Washers
 - 2 Thin Wave Washers
 - 2 Fixed Position Stoppers
- 1 Installation Instructions

REFER TO FIG 1 AND 2 ON PAGE 6

TOOLS SUGGESTED

Set of Hex Wrenches, Hex Socket Set with Ratchet, FT/LBS Torque Wrench, Set of Combination Wrenches, Loctite Threadlocker Blue 248

NOTICE

If installing this product for another party, please make sure they receive this copy of the installation instructions so they are aware of the important information contained in them.

CUSTOMER SERVICE

877.370.3604 (toll free)

INSTALLATION QUESTIONS

techsupport@kuryakyn.com
or call 715.247.2983

LIMITED WARRANTY

Kuryakyn warrants that any Kuryakyn products sold hereunder, shall be free of defects in materials and workmanship for a period of one (1) year from the date of purchase by the consumer excepting the following provisions:

- Kuryakyn shall have no obligation in the event the customer is unable to provide a receipt showing the date the customer purchased the product(s).
 - The product must be properly installed, maintained and operated under normal conditions.
 - Kuryakyn makes no warranty, expressed or implied, with respect to any gold plated products.
 - Kuryakyn shall not be liable for any consequential and incidental damages, including labor and paint, resulting from failure of a Kuryakyn product, failure to deliver, delay in delivery, delivery in nonconforming condition, or for any breach of contract or duty between Kuryakyn and a customer.
- Kuryakyn products are often intended for use in specific applications. Kuryakyn makes no warranty if a Kuryakyn product is used in applications other than intended.
- Kuryakyn electrical products are warranted for one (1) year from the date of purchase by the consumer. L.E.D.'S contained in components of Kuryakyn products will be warranted for defects in materials and workmanship for 3 years from the date of purchase where as all other components shall be warranted for one(1) year. This includes, but is not limited to; control modules, wiring, chrome & other components.

- Kuryakyn makes no warranty of any kind in regard to other manufacturer's products distributed by Kuryakyn. Kuryakyn will pass on all warranties made by the manufacturer and where possible, will expedite the claim on behalf of the customer, but ultimately, responsibility for disposition of the warranty claim lies with the manufacturer.

ABOUT OUR CATALOG

For purchasing Kuryakyn® products, you can receive a complete catalog free of charge. Send the Proof-of-Purchase below with your address to: Kuryakyn, P.O. Box 339, Somerset, WI 54025. Please indicate either Accessories Catalog for Harley-Davidson® or GL & Metric Cruisers.

Be sure to ask your local dealer about other Kuryakyn® products, the motorcycle parts and accessories designed for riders by riders.

©2005 Kuryakyn USA® All Rights reserved.





YOU WILL BE WORKING AROUND THE ENGINE AND EXHAUST SYSTEM DURING INSTALLATION. ENSURE THAT THE ENGINE AND EXHAUST SYSTEM HAVE FULLY COOLED TO PREVENT INJURY.

NOTE: In the following instructions, left and right may be referred to as "clutch-side" (left) and "brake-side" (right) for clarity.

STEP 1 Read and understand all steps in the instructions before starting the installation. Park the motorcycle on a hard, level surface and turn off the ignition. Put the motorcycle on its center stand or secure it in a wheel chock. Allow the engine and exhaust system cool.

ERGO III ADJUSTABLE CRUISE MOUNT INSTALLATION:

STEP 2 Locate the clutch-side (left) Ergo III Adjustable Cruise Mount. Refer to PIC 1. There will be an "L" on the backside of the Adjustable Arm as shown in PIC 2. The Mounts are side specific, so ensure that you have the correct Mount before moving on.

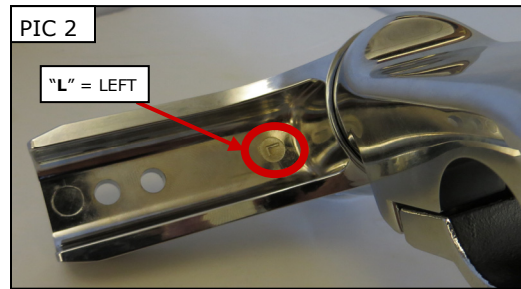
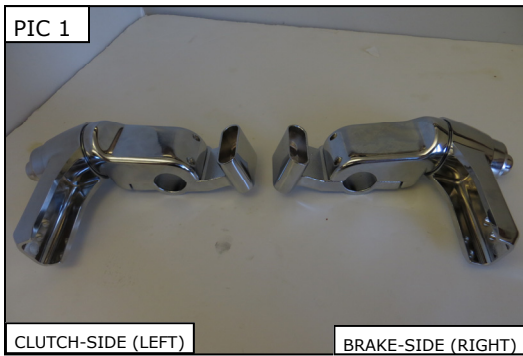

STEP 3 Remove the four screws on the underside of the clutch-side Mount. PIC 3. Set the screws within arms reach of the work area on the clutch-side of the motorcycle.

STEP 4 Loosely install two of the included Set Screws in the bottom clamp-half as shown in PIC 4.

STEP 5 Turn the clamp-half over and position the Adjustable Stop in the bottom clamp-half. PIC 5.

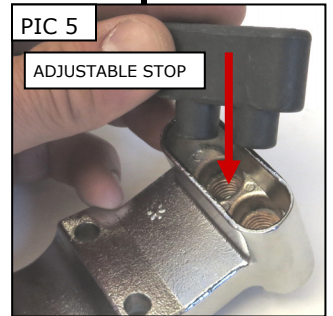
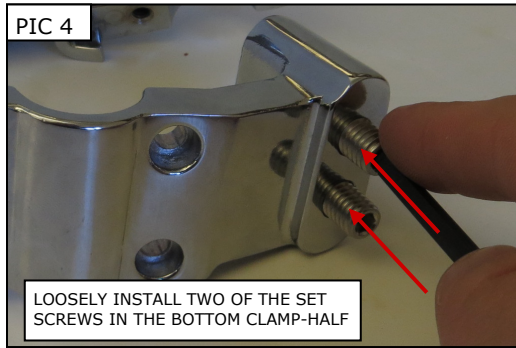
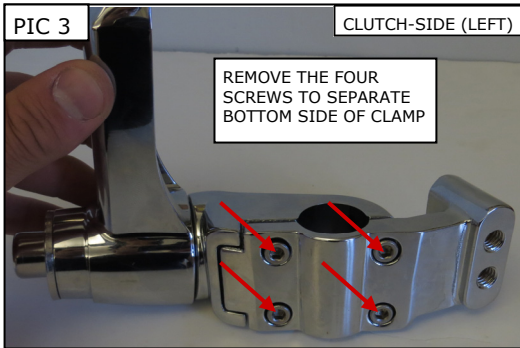

STEP 6 Position the bottom clamp-half under the clutch-side engine guard as shown in PIC 6 and 7 on **PAGE 3**.

-cont.-

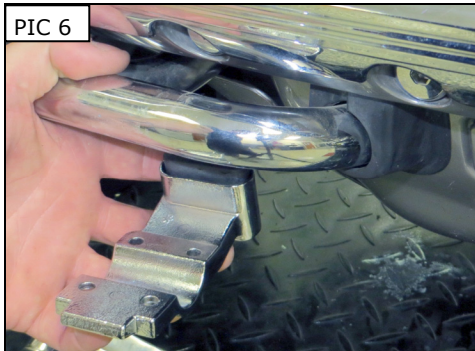

STEP 7 Refer to PIC 8. Position the clutch-side upper clamp-half (separated in **STEP 3**) over the engine guard and align it with the bottom clamp-half. Secure the bottom to the top with the four screws removed in **STEP 3**. PIC 8

NOTE: Do not fully tighten the screws at this time. Leave them snug to allow for adjustment of the mounts.

STEP 8 Repeat **STEPS 2 through 7** for the other side.



EXTENSION ARM AND CLEVIS INSTALLATION:

STEP 9 Locate one of the Extension Arms in the Hardware Kit. The Arms are **NOT** side specific.

STEP 10 Refer to PIC 9 below. The Extension Arms allow for three possible foot positions. **A** shows a possible Extension Arm position for riders with shorter legs. **B** shows the position for riders with medium length legs. **C** shows the position for riders with longer legs. Determine which Extension Arm position will suit you best.

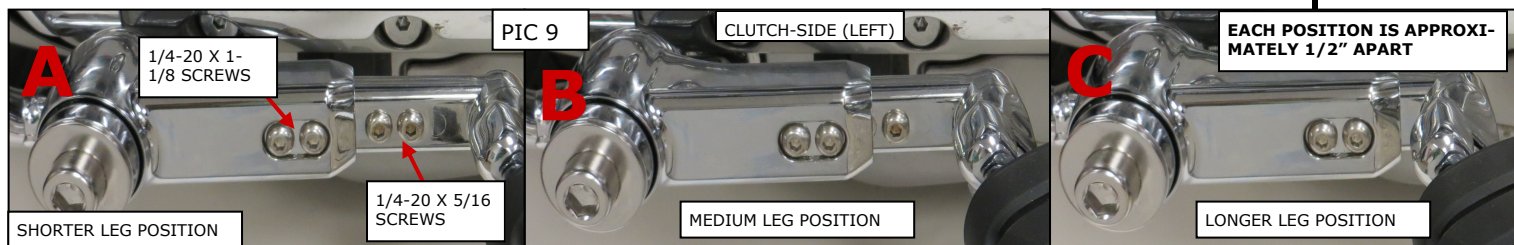

STEP 11 On the clutch-side of the bike, attach the Extension Arm to the Rotating Arm with two of the included 1/4"-20 X 1-1/8" Button Socket Head Screws. Thread the screws through the Extension Arm and secure them on the back side with two of the included Nylock Nuts. Fill any exposed threaded holes with the included 1/4"-20 X 5/16" Button Socket Head Screws. PIC 9 **A Torque the screws to 10 FT/LBS.**

-cont.-



FAILURE TO ADJUST FOOTPEG STOP SO THEY FOLD UPWARD AND REARWARD IF CONTACTED BY ANY OBJECT COULD RESULT IN LOSS OF CONTROL THAT COULD RESULT IN SERIOUS INJURY OR DEATH.

STEP 12 Determine the left footpeg clevis from the right. PIC 10 When installed, the left clevis will have its footpeg stop on the top side and the screw hole will face the rear of the bike. PIC 10

NOTE: Place a drop of Loctite Threadlocker Blue 248 on the threads of the clevis and footpeg screws before installing. Follow the manufacturer's recommendations for proper application.

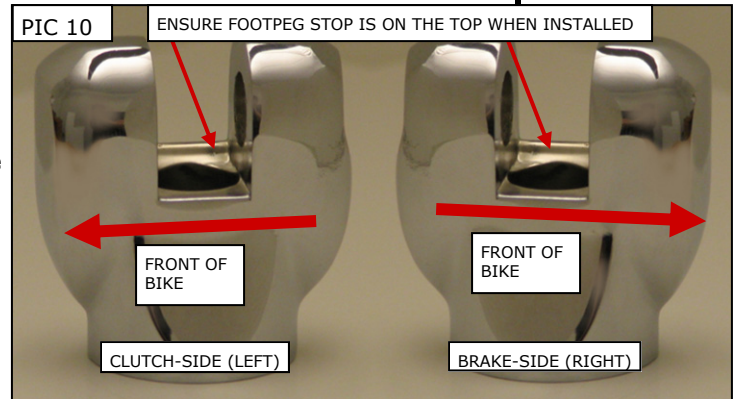

STEP 13 Apply some Blue Loctite (248) to one of the 3/8"-16 X 1" Socket Head Cap Screws. Install the clutch-side footpeg clevis on the Extension Arm. Secure it with one of the 3/8" Screws. Leave the screw loose until the clevis has been adjusted.

STEP 14 Push down on the Rotating Arm until it reaches its stop; adjust the angle of the clevis so the footpeg will fold up and back at an angle. Ensure the splines on the clevis and arm engage and tighten the screw. **Torque the screw to 20 FT/LBS.**

FOOTPEG INSTALLATION:

NOTE: Even though the picture below shows a different footpeg than the one included in this kit, the installation of the Premium Mini Board is the same.

STEP 15 Apply some Blue Loctite (248) to the 5/16"-18 X 1" footpeg screw threads. Install the clutch-side footpeg in the clevis and secure it with the 5/16" footpeg screw. PIC 11 If necessary, use the included Wave Washers to take up any excess space between the footpeg adapter and the clevis. **Torque the screw to 25 FT/LBS.**

STEP 16 There are three splined mounting holes in the Mini Board. You may use these holes to position the Board forward or rearward, angled up or down. To adjust the Mini Board, remove the 5/16"-18 socket head cap screw and washer from the Mini Board. This will leave the adapter in the clevis. Choose the position of the Mini Board, then insert the 5/16"-18 socket head cap screw, with flat washer, through the Mini Board and thread it into the mount. Ensure the splines are engaged, then tighten the screw securely.

STEP 17 Repeat **STEPS 9 through 16** for the other side.



-cont.-

FINAL ADJUSTMENT:

NOTE: Additional adjustment of the Ergo III Adjustable Cruise Mounts can be made for Mount angle and leg room. If additional adjustment is needed follow the STEPS below.

STEP 18 **Additional Mount angle adjustment:** Loosen the four screws from **STEP 7**. Turn the two Set Screws on the bottom clamp-half clockwise to increase the mount angle. Turn the screws counterclockwise to lower the angle. Adjust the Set Screws evenly, then tighten the four clamp-half screws.

STEP 19 **Additional leg room adjustment:** Loosen the four screws from **STEP 7**. Carefully slide the mount along the engine guard until you get the desired position. Tighten the four screws.



THE ROTATING ARM CAN BE POSITIONED IN A WAY THAT GREATLY DECREASES CORNERING CLEARANCE WHICH MAY CAUSE LOSS OF CONTROL RESULTING IN SERIOUS INJURY OR DEATH. ENSURE THAT THE ROTATING ARM IS POSITIONED PARALLEL TO OR ABOVE THE ENGINE GUARD WHEN IN THE UNLOADED POSITION. REMOVE YOUR FEET FROM THE FOOTPEG WHEN CORNERING TO AVOID LOSS OF CONTROL.

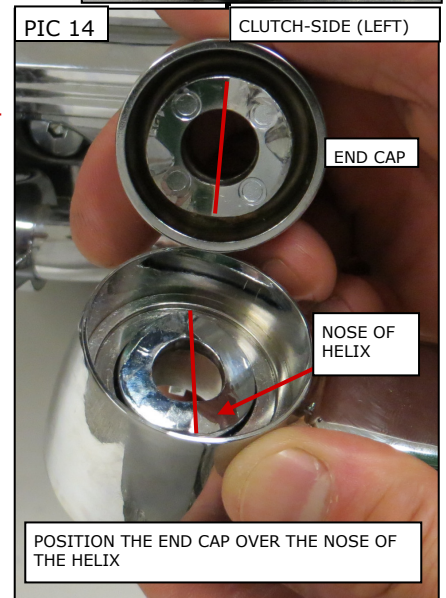
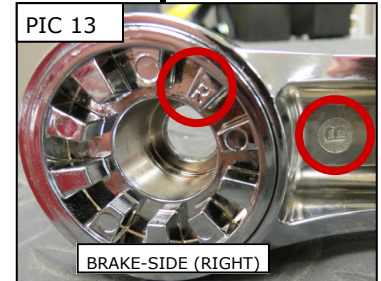
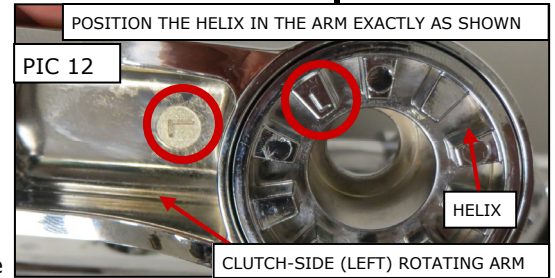

OPTIONAL HORIZONTAL FIXED-ARM INSTALLATION:

STEP 20 On the clutch-side of the bike. Remove the 1/2" Screw and Washer that holds the Rotating Arm to the Mount. Set them aside, they will be re-used. Remove the Rotating Arm, Helix and End Cap from the mount. The inside of the Arm and Helix are marked with an "L". Refer to PIC 12 and 14.

STEP 21 Remove the Spring, Steel Bushing, and Brass Bushing. Set these aside, they will NOT be reused.

STEP 22 Position the Helix in the Rotating Arm so that the "L" on the Helix aligns with the "L" on the Arm EXACTLY as shown in PIC 12. Refer to PIC 13 for the brake-side.

STEP 23 Hold the Helix in place in the Rotating Arm and position the End Cap over the nose of the Helix. PIC 14 Turn the End Cap until it settles into place on the nose of the Helix as shown in PIC 15.

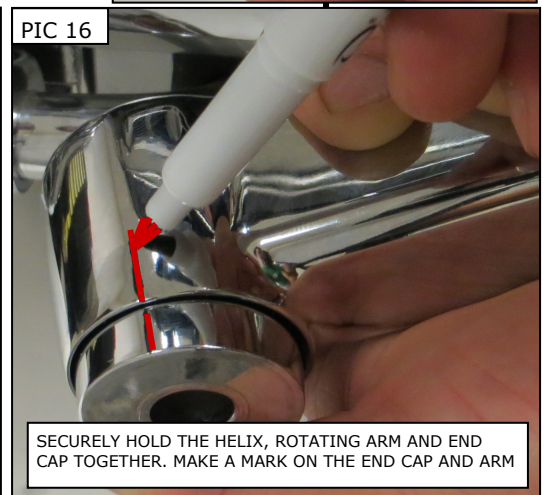
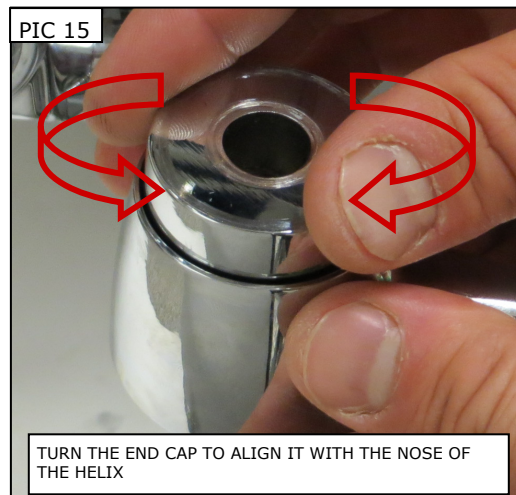

STEP 24 Holding everything in place, make a mark on the End Cap and Rotating Arm with a non-permanent marker as shown in PIC 16.

-cont.-

- STEP 25** Test fit the assembly on the Ergo III mount. With the Helix engaged on the cogs of the Ergo III mount, pull up on the arm to ensure that the Arm assembly will be in the correct position.
- STEP 26** Remove the End Cap and install an included Fixed Position Stopper in place of the Spring and Steel and Brass Bushings. Reinstall the Rotating Arm, Helix (still aligned exactly as shown in PIC 12 or 13).
- STEP 27** Insert the 1/2" Screw and Washer (removed in **STEP 20**) through the Rotating Arm assembly. Thread it into the Mount. **Torque the 1/2" Screw to 30 FT/LBS.**
- STEP 28** Repeat **STEPS 20 through 27** for the other side.
- STEP 29** If necessary, make any other adjustments by referring to **STEPS 10 through 19.**

ERGO III ADJUSTABLE CRUISE MOUNT CARE:

Do not wash with a pressure washer. The water pressure may remove the grease.

Periodic greasing may be necessary to maintain proper function. FIG 1 and 2

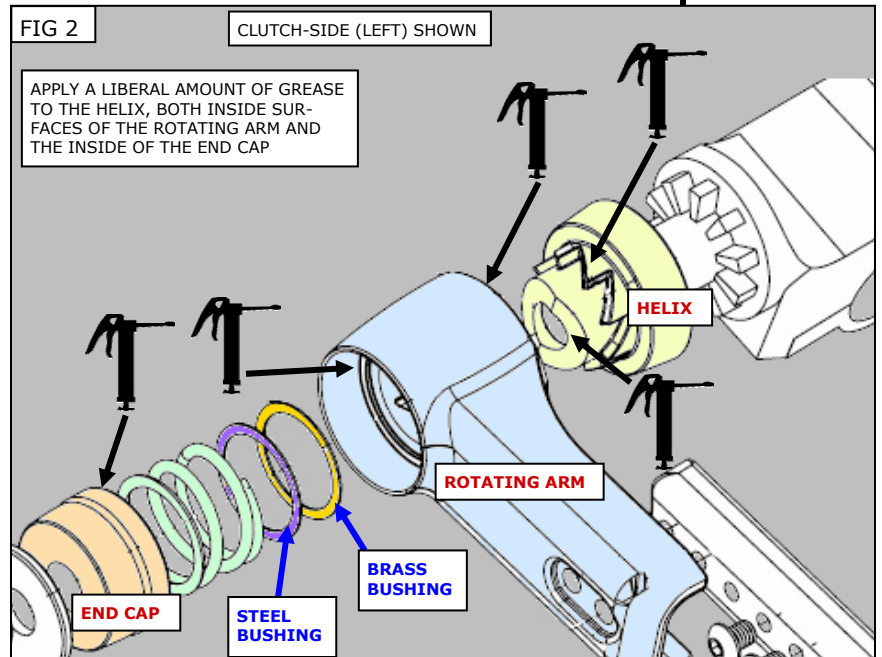
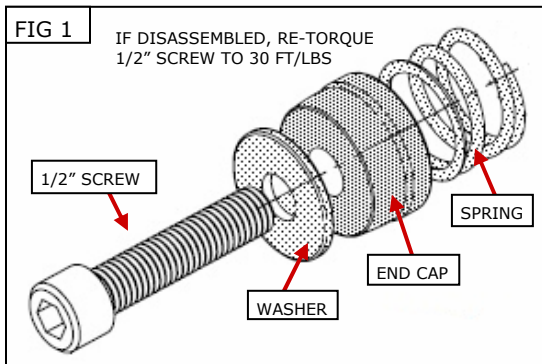

NOTICE

It is the end user's responsibility to ensure that all of the fasteners (including pre-assembled) are tightened before operation of the motorcycle. Küryakyn will not provide warranty coverage on products or components lost due to improper installation or lack of maintenance. Periodic inspection and maintenance are required on all fasteners.

Ride On!